

Alu-Room² XL

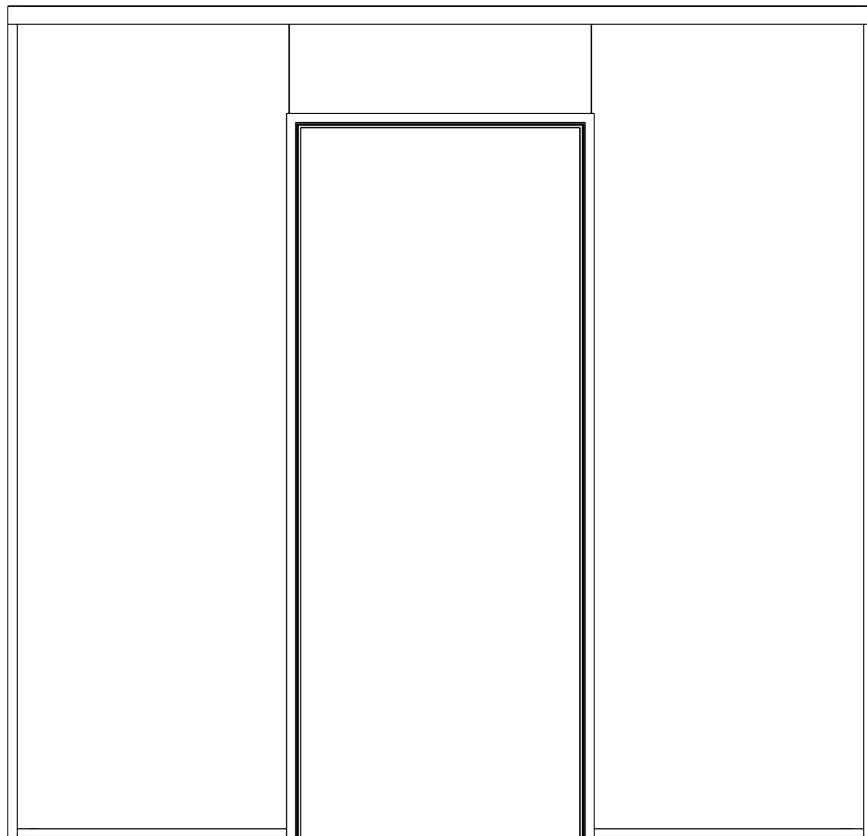

Monteringsvejledning A
Alu-Room² XL-profiler med Alu-Karm

Tag **Alu-Room² F40 XL**
Væg og gulv **Alu-Room² D27 XL / D40 XL**



Alu-Room² Monteringsvejledning A

1 Monter dørkarmen med hjørner og Alu-Room XL profilens gulvbeslag.

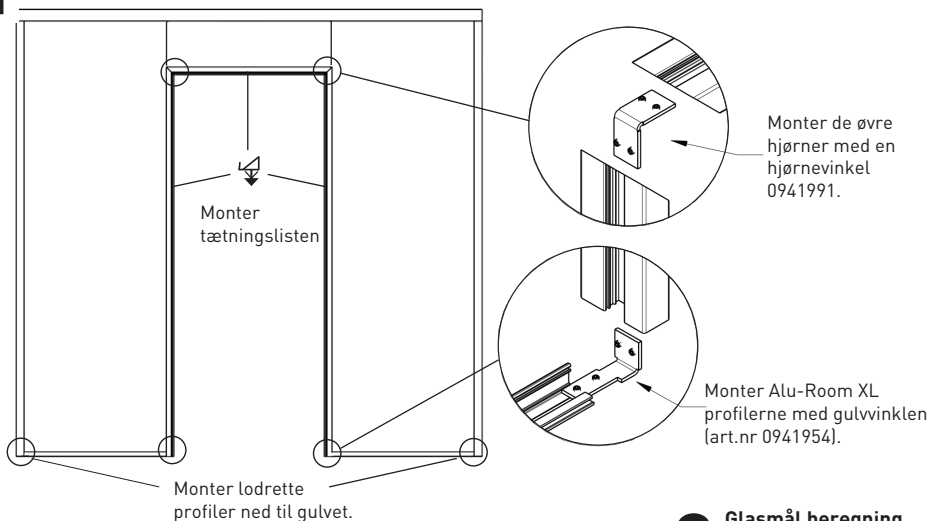

2 Glasmål beregning

Glasmål beregning
(glassets mål med små bogstaver)
 Sideglas: $b=B1-11\text{ mm}$. $h=H-30\text{ mm}$.
 Overlys glas inkl. samleliste: $b=RUD-23\text{ mm}$. $h=H-2100\text{ mm}$ (hvid standardkarm)

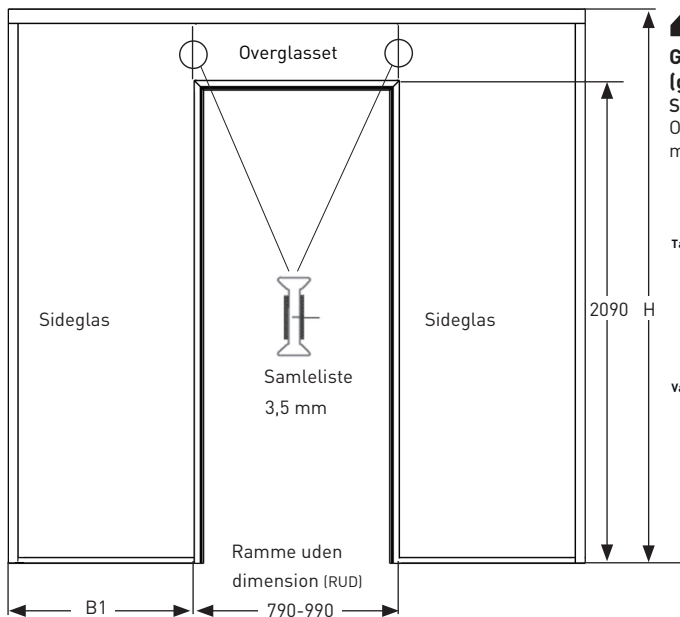

Tagprofil - F40 XL

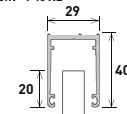

Væg- og gulvprofil - D27 XL

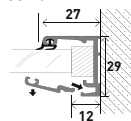

D40 XL

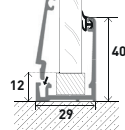
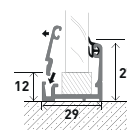
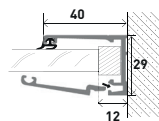

For endnu bedre lydæmpning, brug 2x8 mm gummibånd under profilerne (art nr 0701630 - hvid eller 0701640 - sort).

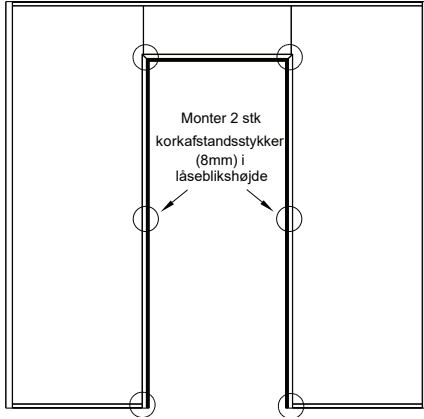

3 Montering af glas

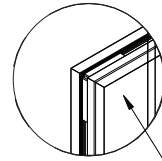

Monter de medfølgende korkafstandsstykker (art nr 09411989) på begge sider af hjørnebeslaget og på karmsiden af gulvbeslaget

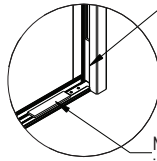

Monter glasklodsser (art nr 0701857) i gulvprofilen.

1. Monter de faste gummiprofiler og karm
2. Monter sideglasset som vist herunder.
3. Monter overlys glasset ved at skubbe det op i tagprofilen og derefter ind i rammen.
4. Monter låsen på Alu-Room² F40 XL.
5. Monter kilgummiet.

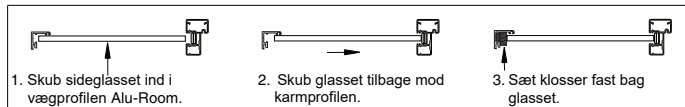

| Glastykkelse | Alu-Room ² | | Glastykkelse | Alu-Room ² XL | |
|--------------|-----------------------|------------|--------------|--------------------------|------------|
| | Kilegummi | Fast gummi | | Kilegummi | Fast gummi |
| 4 | 070 2027x | 1003081x | | | |
| 6 - 8,76 | 0702025x | 1003081x | | | |
| 8,76-10 | 0700369x | 1003081x | | | |
| 10,76 | 0700369x | ————— | 10-10,76 | 070 2027x | 1003081x |
| 12,76 | | | 12,76 | 070 2025x | 1003081x |
| 16,76 | | | 16,76 | 070 0369x | ————— |



www.interglas.dk

Version 1.5



999441