



**Item number: INT925**

### **Description:**

The Interglas INT925 SEAL is a automatic door bottom seal which is spring loaded to lift clear of the floor as soon as the door leaf is opened by a few millimeters.

An acoustically designed seal for surface mounted applications. It is operated automatically by pressure against the door jamb on its plunger and seals when the door closes and retracts automatically when the door is opened.

Can be fitted on the internal side of the door using the frame to activate the plunger or externally using the bumper provided.

The possibility of changing the side of the push plunger

15mm maximum drop, Seal drops on plunger side first.

Suitable for all types of swing doors.

### **Specification:**

- **Noise Reduction Index:** Rw up to Rw 37dB
- **Maximum Drop:** 15mm.
- **Seal Lengths:** 925mm
- **Maximum trimming:** 100mm which will take your seal length to 825mm.

*Interglas ApS, Kornmarksvej 10, DK-2605 Brøndby, Danmark,*

*email: [ordre@interglas.dk](mailto:ordre@interglas.dk), telefon: 21 21 63 63*

## Fitting instructions:

1. If you install the profile on the glass with aluminum frame place profile on the closing side of glass door.

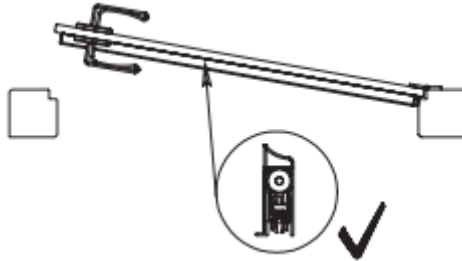

2. If you install the profile on the glass door without frame place activating kit fitting on the glass wall on the closing side of glass door.

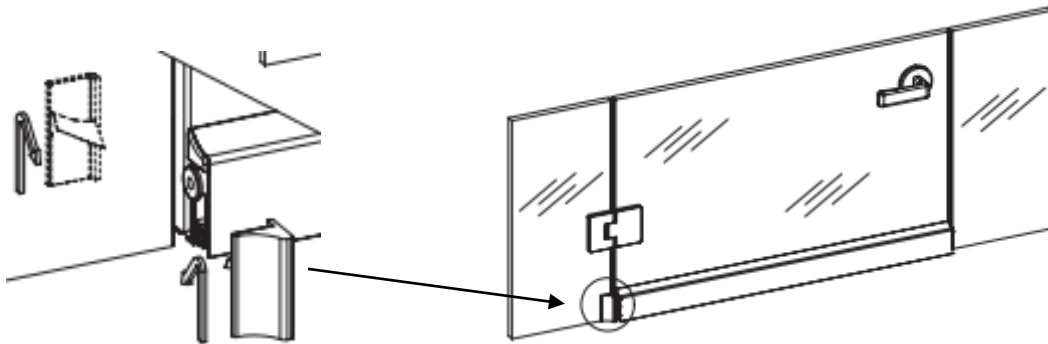

3. If you would like to reverse the side of the plunger, caused by the side of your door opening, Left or Right.

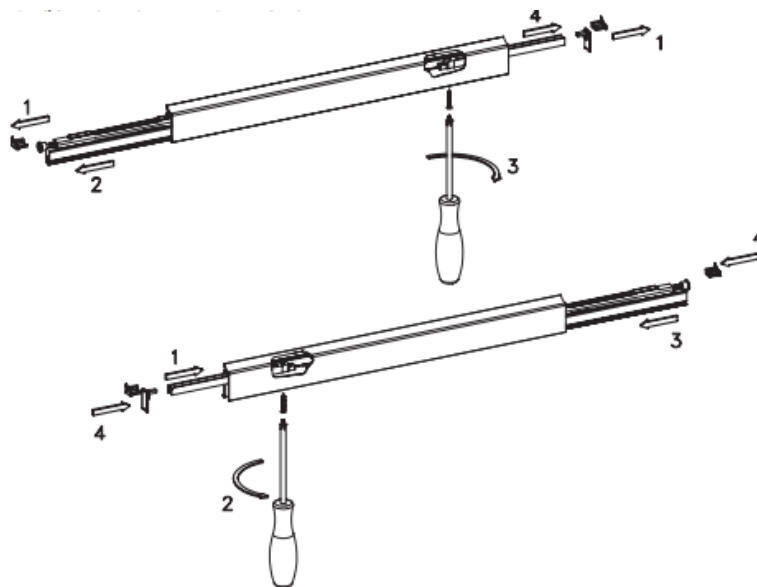

Interglas ApS, Kornmarksvej 10, DK-2605 Brøndby, Danmark,

email: [ordre@interglas.dk](mailto:ordre@interglas.dk), telefon: 21 21 63 63

4. Short the profile up to 100mm on the opposite side of plunger but remove first two endcaps from the cutting side.



5. Peel the protection film from double tape from the profiles and stick the profiles to the glass.

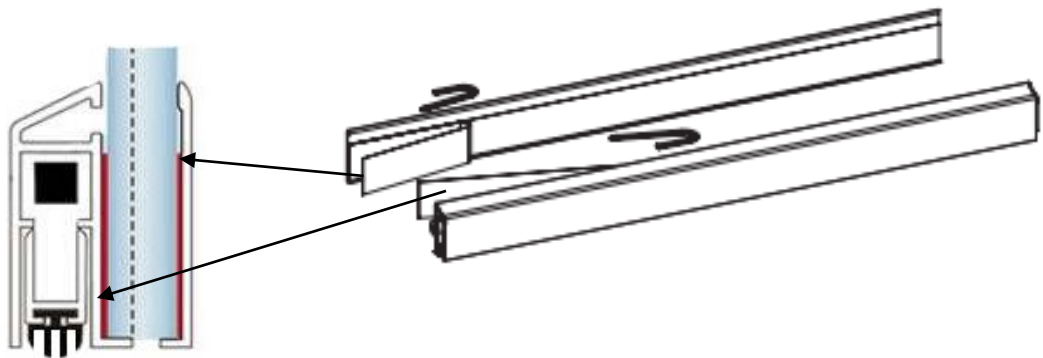

6. Adjust the sealing gap.



Interglas ApS, Kornmarksvej 10, DK-2605 Brøndby, Danmark,

email: [ordre@interglas.dk](mailto:ordre@interglas.dk), telefon: 21 21 63 63